

Spoked handwheels

Duroplast, large diameter hub

MATERIAL

High-strength, reinforced phenolic based (PF) Duroplast black colour, glossy finish.

STANDARD EXECUTIONS

Large diameter black-oxide steel hub, uncovered front end with spot-drilling.

- **VRU.:** without handle.
- **VRU+I:** with revolving handle I.301+x (see page 574) in Duroplast.

ACCESSORIES ON REQUEST

Axial retaining washer GN 184 (see page 971).

Execution examples for special applications

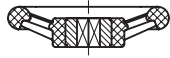

Square pass-through hole



Drive hole

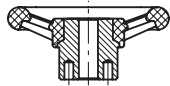

Extended hub with spring-loaded ball locking mechanism

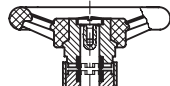

Extended hub toothed coupling

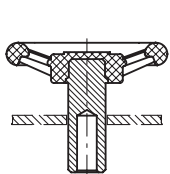

Extended hub for bulkhead assembly

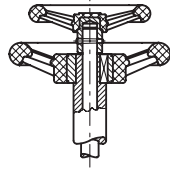

Controlling coaxial shafts



ELESA Original design

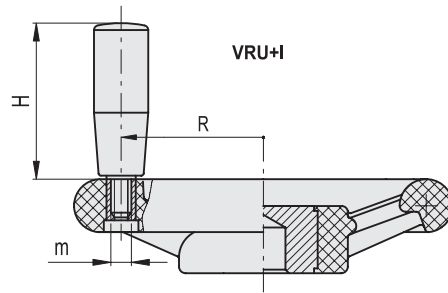
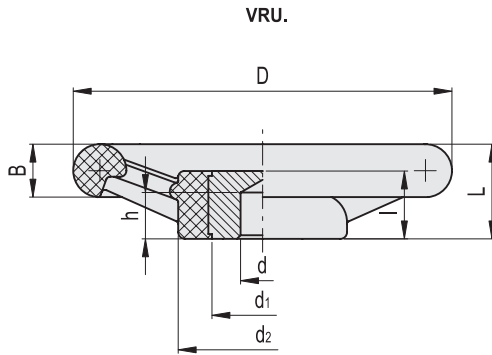

VRU.

| Code | Description | D | dH9 | L | B | d1 | d2 | l | h | C# [Nm] | L# [J] | ⚖ |
|-------|-------------|-----|-----|----|----|----|-----|----|----|---------|--------|------|
| 80001 | VRU.125 | 125 | 10 | 28 | 18 | 32 | 55 | 22 | 15 | 220 | 9 | 315 |
| 80101 | VRU.160 | 160 | 10 | 35 | 22 | 42 | 70 | 26 | 17 | 350 | 13 | 615 |
| 80201 | VRU.200 | 199 | 12 | 40 | 26 | 53 | 85 | 27 | 20 | 450 | 20 | 990 |
| 80301 | VRU.250 | 249 | 12 | 49 | 30 | 68 | 105 | 30 | 22 | 650 | 25 | 1770 |

VRU+I

| Code | Description | D | dH9 | L | B | d1 | d2 | l | h | H | m | R | C# [Nm] | L# [J] | ⚖ |
|-------|-------------|-----|-----|----|----|----|-----|----|----|----|-----|----|---------|--------|------|
| 80011 | VRU.125+I | 125 | 10 | 28 | 18 | 32 | 55 | 22 | 15 | 65 | M8 | 47 | 220 | 9 | 400 |
| 80111 | VRU.160+I | 160 | 10 | 35 | 22 | 42 | 70 | 26 | 17 | 65 | M8 | 60 | 350 | 13 | 700 |
| 80211 | VRU.200+I | 199 | 12 | 40 | 26 | 53 | 85 | 27 | 20 | 80 | M10 | 75 | 450 | 20 | 1130 |
| 80311 | VRU.250+I | 249 | 12 | 49 | 30 | 68 | 105 | 30 | 22 | 80 | M10 | 99 | 650 | 25 | 1910 |

For maximum torque (C) and impact strength (L) see Technical Data on page A3.

